



SPECIFICATIONS

Input Voltage.....	208-240VAC Single Phase
Kilowatt Rating.....	6.0
Maximum Amperage.....	28 AMPS
Water Inlet.....	3/8" NPT
Steam Outlet.....	1/2" NPT
Electrical connection.....	Hard-wired
Maximum Room Size (cubic Feet).....	84

Steam Suite Basic features:

- Simple Sized – no complicated “tax return” formulas
- Constant steam at a constant rate (no steam lags or bursts)
- 2 Year in Home; Five year “no questions asked” factory warranty.
- Can be plumbed 50 feet from the shower enclosure without having to purchase a larger kW unit.
- Control features: Day Clock, Time/temperature, 2 memory settings, all metal construction.

Installation Notes:

Install this generator according to the supplied installation guide. Follow local plumbing and electrical codes. Unit must be accessible.

Generator is factory sized: L x W x H = Cubic Feet. Choose the appropriate generator. For every additional foot of ceiling height over 8 ft, use the next larger generator. Always round up when calculating the total cubic feet.



Product Specification:

The steam generator shall approximately be 17.5" x 6.25" x 9.5" in dimension. The generator tank shall be made from stainless steel, this package includes an Elite controller 5.5" x 3.38" x 3/4", and a Deluxe Steam head 2.5"Dia x 2".

Shipping Information:

Weight.....21 lbs.
 Length.....20 in.
 Width.....7 in.
 Height.....11 in.

*select desired finish and replace the XX with the code

PC = Polished Chrome
 SN = Satin Nickel
 ORB = Oil Rubbed Bronze

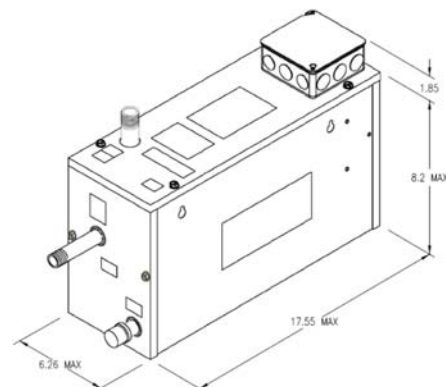

For any further assistance please contact ThermaSol at 800.776.0711 or sales@thermasol.com

Visit www.thermasol.com for a complete product definition